

BILLION[®]

Networking Communication

Product Portfolio

Reliable M2M and ISP/Telcos Solutions
Explore New Revenue Generating Opportunities and Deliver the World to You

BILLION[®]



© Copyright 2022.v1 Billion Electric Co., Ltd. All rights reserved.

Billion[®] and all names, technology, product, and service names referenced herein are registered trademarks of Billion Electric Co., Ltd. The content herein is subject to change without prior notice.

www.billion.com



“ Aim to establish Win-Win Partnership with distributors, SIs, and ISPs around the world.

Since 1992, our Communication Division has been committed to the development, manufacture, and brand marketing of internet access devices.

Targeting the service integrators, SIs, VARs, and distributors, we provide a comprehensive portfolio of customizable, wired/wireless CPE devices to multi-national customers across five continents. Dedicated to developing In-Vehicle, M2M/Industrial IoT, Outdoor, Financial, and Networking equipment Solutions.

Ranging from xDSL, Fiber, Wi-Fi 5/Wi-Fi 6, fixed 5G/LTE Indoor and outdoor, and M2M/Industrial IoT routers.

Our complete line of networking products not only turns quality, stability, flexibility, and attentive service into reality but also consistently offers these important values to our customers.



Content

M2M/Industrial IoT Series

- M600-PT
- M600
- M500
- M120N
- M100/M150
- M100-NB
- M50UG
- M50G
- 4220Z
- 4220NZ
- 121P
- 110NP
- 8206AZ
- 8920NZ
- 8207(V)AZ
- 8208AZ

5G NR Indoor Series

- 5500A

5G NR Outdoor Series

- 5700

LTE Indoor Series

- 4520VAOZ R3
- 4520AZ R3
- 4500VAOZ R3
- 4500AZ R3
- 4520VNO(P)Z R2
- 4520NZ(L) R2
- 4500VNO(P)Z R2
- 4500NZ(L) R2

LTE Outdoor Series

- 4700AZ
- 4700ZU
- 4700ZUL
- 4600

xDSL Series

- 8900X R3

xDSL+ Wireless AP

- 8206AZ
- 8207AZ
- 8200AXL-1200
- 8700NEXL R2
- 8700NEXL R3
- 8700AXL-1600
- 8900AX-1600 R2
- 8900AX-2400
- 8920AXL

xDSL+Wireless AP+VoIP

- 8207VAZ
- 8700VAXL-1600

P2P Fibre Series

- 9900VA

Industrial/In-Vehicle Routers

M600-PT



M600



M500



M120N



LTE Industrial/In-Vehicle Multi-Carrier Router

LTE Industrial/In-Vehicle Multi-Carrier Router

LTE Industrial/In-Vehicle Multi-Carrier Router

LTE Industrial/In-Vehicle Multi-Carrier Router

WAN Interface				
LTE	●	●	● (x2)	●
Ethernet WAN	● GbE (*1)	● GbE (*1)	● GbE (*1)	● GbE (*1)
Hardware Interface				
SIM slot	● (x2)	● (x2)	● (x2)	● (x2)
Gigabit Ethernet	● (M12 x4) (Configurable EWAN x1)	● (RJ45 x4) (Configurable EWAN x1)	● (RJ45 x4) (Configurable EWAN x1)	● (RJ45 x4) (Configurable EWAN x1)
USB Host	● (USB 2.0 x1)	● (USB 2.0 x1)	● (USB 2.0 x2)	-
802.11n (2.4 GHz)	● (600Mbps)	● (600Mbps)	● (300Mbps)	● (300Mbps)
802.11ac (5 GHz)	● (1.7 Gbps)	● (1.7 Gbps)	-	-
GPS	●	●	●	● (optional)
mini USB	-	-	● (x2)	-
Serial port (RS-232/RS-485)	-	-	-	● (DB9 x1)
Features				
VPN	●	●	●	●
IPv4 / IPv6	●	●	●	●
Dual WAN (Failover/Failback)	●	●	●	●
Dual WAN (Load Balance)	●	●	●	●
Dual APNs	● (*2)	● (*2)	● (*2)	● (*2)
Dual Firmware Images	●	●	●	●
Metal Casing	●	●	●	●
Operating temperature	-40°C ~ 60 °C	-40°C ~ 60 °C	-40°C ~ 60 °C	-40°C ~ 60 °C

*1 : Software configurable EWAN.

*2 : Dual APNs is only upon request for Telco/ ISP tender projects.

Advanced Industrial Routers

USB Dongle

M100/M150



M100-NB



M50UG



M50U



Advanced Industrial
LTE Router

Industrial LTE
eMTC/NB-IoT Router

LTE USB Dongle

LTE USB Dongle

WAN Interface				
LTE	●	● (*1)	● (MOMO 4x4)	● (MOMO 2x2)
Ethernet WAN	● GbE (*2)	● GbE (*2)	-	-
Hardware Interface				
SIM slot	● (x1)	● (x1)	● (x2)	● (x2)
Gigabit Ethernet	● (RJ45 x2) (Configurable EWAN x1)	● (RJ45 x2) (Configurable EWAN x1)	-	-
GPS	● (optional)	● (optional)	● (optional)	● (optional)
Serial port (RS-232/RS-485)	● (DB9 x1)(*3)	● (DB9 x1)(*3)	-	-
Features				
VPN	●	●	-	-
IPv4 / IPv6	●	●	●	●
Dual WAN (Failover/Failback)	●	●	-	-
Dual WAN (Load Balance)	●	●	-	-
Dual APNs	● (*4)	● (*4)	-	-
Dual Firmware Images	●	●	-	-
Metal Casing	●	●	●	●
Operating temperature	-20°C ~ 60 °C	-20°C ~ 60 °C	-40°C ~ 60 °C	-40°C ~ 60 °C

*1: eMTC/NB-IoT (Cat.M1/Cat.NB1)

*2: Software configurable EWAN.

*3: M100, M100-NB supports RS-232 only. / M150 supports either RS-232 and RS-485.

*4: Dual APNs is only upon request for Telco/ ISP tender projects.

M2M Routers

BiPAC 4220Z



LTE Embedded Firewall Router

BiPAC 4220NZ



LTE Embedded Wireless Firewall Router

BiPAC 121P



LTE Triple-SIM VPN Router

BiPAC 110NP



Mini LTE Wireless VPN Router

WAN Interface				
LTE	●	●	●	●
Ethernet WAN	● GbE (*1)	● GbE (*1)	● (configurable via firmware)	● (configurable via firmware)
Hardware Interface				
SIM slot	● (x2)	● (x2)	● (x3)	● (x1)
Gigabit Ethernet	● (x2) (Configurable EWAN x1)	● (x2) (Configurable EWAN x1)	● (RJ45 x2)	● (RJ45 x2)
802.11n (2.4 GHz)	-	● (300Mbps)	-	● (300Mbps)
GPS	-	-	-	● (optional)
PoE-PD	-	-	●	●
Features				
VPN	●	●	●	●
IPv4 / IPv6	●	●	●	●
Dual WAN (Failover / Failback)	●	●	●	●
Dual WAN (Load Balance)	●	●	●	●
Dual APNs	●	●	●	●
Dual Firmware Images	●	●	●	●
Operating temperature	0°C ~ 40 °C	0°C ~ 40 °C	0°C ~ 40 °C	0°C ~ 40 °C

*1: Software configurable EWAN.

M2M Routers

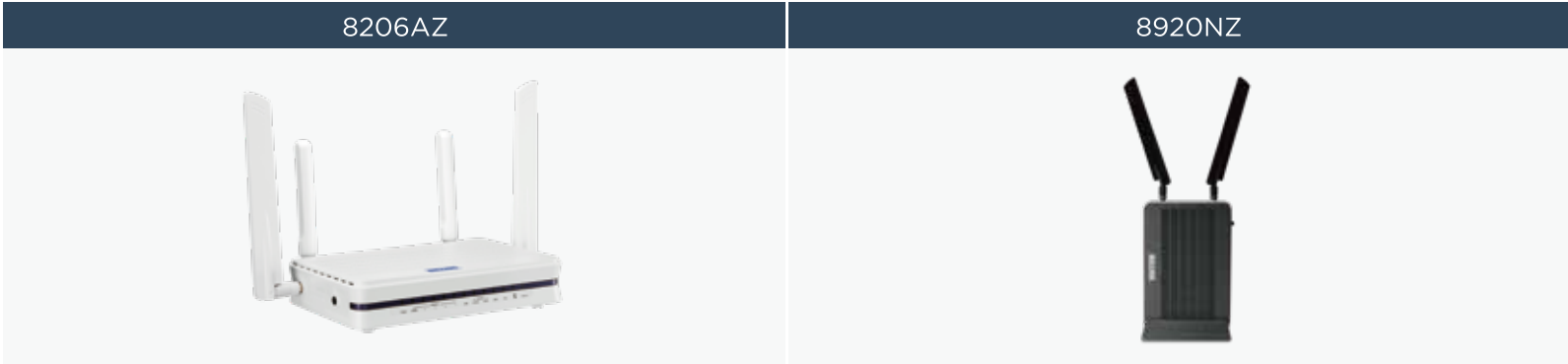

8206AZ

8920NZ



LTE Embedded
V/ADSL2+ Wi-Fi 5 AC 1200
VPN Firewall Router



Dual-SIM LTE Embedded
V/ADSL2+ Wireless-N
VPN Firewall Router

WAN Interface	8206AZ	8920NZ
LTE	●	●
V/ADSL	●	●
Ethernet WAN	● (*1)	● (*1)
Hardware Interface		
SIM slot	● (x1)	● (x2)
Gigabit Ethernet	● (x5) (Configurable EWAN x1)	● (x5) (Configurable EWAN x1)
USB Host	● (USB 2.0 x1)	● (USB 2.0 x1)
802.11n(2.4GHz)	● (300Mbps)	● (300Mbps)
802.11ac(5 GHz)	● (867Mbps(2x2))	-
FXS	-	-
Features		
VPN	●	●
IPv4 / IPv6	●	●
VLAN MUX	●	●
Dual WAN (Failover / Failback)	●	●
Dual WAN (Load balance)	●	●
Operating temperature	0°C ~ 40 °C	0°C ~ 40 °C

*1: Software configurable EWAN.

M2M Routers



5G/LTE Embedded
V/ADSL2+ Wi-Fi 6 AX 1500
VPN Firewall Router



5G/LTE Embedded
V/ADSL2+ Wi-Fi 6 AX 1500
VoIP VPN Firewall Router



5G/LTE Embedded
V/ADSL2+ P2P Wi-Fi 6 AX 1500
VPN Firewall Router

	8207AZ	8207VAZ	8208AZ
WAN Interface			
5G/LTE	●	●	●
Ethernet WAN	● (*1)	● (*1)	● (*1)
V/ADSL	●	●	●
P2P GbE Fiber (SFP)	-	-	●
Hardware Interface			
SIM slot	● (x1)	● (x1)	● (x1)
Gigabit Ethernet	● (x4) (Configurable EWAN x1)	● (x4) (Configurable EWAN x1)	● (x3 + 1(2.5GbE))
USB Host	● (USB 2.0 x1)	● (USB 2.0 x1)	● (USB 2.0 x1)
802.11n (2.4GHz)	● (300Mbps)	● (300Mbps)	● (300Mbps)
802.11ax (5 GHz)	● (1200Mbps(2x2))	● (1200Mbps(2x2))	● (1200Mbps(2x2))
FXS	-	● (x1)	-
Features			
VPN	●	●	●
IPv4 / IPv6	●	●	●
VLAN MUX	●	●	●
Dual WAN (Failover / Failback)	●	●	●
Dual WAN (Load Balance)	●	●	●
Operating Temperature	0°C ~ 40 °C	0°C ~ 40 °C	0°C ~ 40 °C

*1: Software configurable EWAN.



BILLION[®]

Prepare your business for M2M solutions
with BILLION Industrial IoT LTE Router





Billion CMS Central Management System

Billion CMS is a standalone centralized management system that allows service providers and system integrators to monitor the status and performance of the terminals and remotely manage Billion devices.



Maximize the operational efficiency



Saving the cost for on site support



Streamline deployment & centralize maintenance

Billion CMS

Central Management System

Designed for service provider and system integrator to remotely control and manage Billion 5G/LTE routers, M2M routers, and VDSL/ADSL business routers, enabling users to minimize deployment, cut supporting service expenses, and maximize operational efficiency.

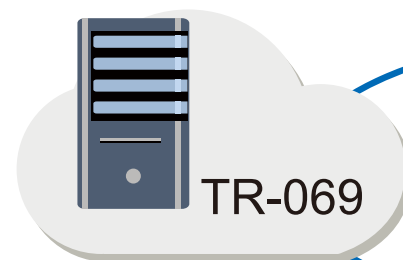

M2M & LTE Embedded

M series/4500 series/4700series

xDSL 5G/LTE Embedded

8206AZ/8206AZ R2

xDSL

89/87/82 series

Explore New Possibilities

Delivering next-generation wireless WANs solutions based on 4G LTE and 5G NR to address critical business needs

Billions 5G NR Access Solutions

Indoor and outdoor gateways provide operators the flexibility to deliver 5G NR over Sub-6GHz with the fastest wireless broadband speeds and a more powerful subscriber experience.

5G NR Indoor Routers

5500A



5G NR Dual-Band
Wi-Fi 5 AC 2400 VPN Firewall
Router

WAN Interface	
5G NR	●
Ethernet WAN	● GbE (*1)
Hardware Interface	
SIM slot	● (x1)
Gigabit Ethernet	● (x4) (Configurable EWAN x1)
802.11n (2.4GHz)	● (600 Mbps (3x3))
802.11ac (5GHz)	● (1733 Mbps (4x4))
USB Host	● (USB 2.0 x1)
Features	
VPN	●
Dual APN	● (*2)
Dual WAN (Failover/Failback)	●
Dual WAN (Load Balance)	●
IPv4 / IPv6	●
Operating temperature	0°C ~ 40 °C

LTE Outdoor Routers

5700



5G NR Outdoor VPN Router

WAN Interface	
5G NR	●
Ethernet WAN	-
Hardware Interface	
SIM slot	● (x1)
Gigabit Ethernet	● (x1)
802.11n (2.4GHz)	-
802.11ac (5 GHz)	-
PoE-PD	●
Features	
VPN	●
Dual APN	● (*2)
Dual-WAN (Failover/Failback)	-
Dual-WAN (Load balance)	-
IPv4 / IPv6	●
IP67	●
Operating temperature	-40°C ~ 60 °C

*1: Software configurable EWAN.

*2: Dual APNs is only upon request for Telco/ ISP tender projects.

Specially designed for Carrier-Grade operations

Designed to create new opportunities for network operators to deliver a cost-efficient broadband service in rural and remote communities.

Billion Outdoor LTE products have thousands of installed bases in North America and other areas.

Our Outdoor LTE routers offer superior RF engineering and a stable operating system for maximum LTE performance, as well as comprehensive networking solutions that are ready to be utilized in a diversity of revenue-generating applications and vertical markets.

To meet the customer's demands for rich, immersive broadband experiences

This solution can help operators to extend the coverage and improve service to your customers at a fraction of the cost of existing fiber-to-the-premises solutions.

Outdoor LTE (VPN) Router

Covered with Industrial-Grade Ingress Protection Rating IP67

Embedded with the water-proofed capability that can sustain in the harshest outdoor weather without cracking the housing.



Can work reliably in freezing or extremely hot environments for extensive times



For delivering optimal network connectivity to all oil and mining sites, as well as serving as the reliable communication backbones for critical communication application



Oil Rig



Tower



Management Center





Outdoor LTE Dual-Band Wi-Fi Hotspot Router

**Deliver Consistent Performance
even in the
Most Challenging Environments**

The cores of Billion Outdoor LTE Router technologies include

- ◆ Optimized antenna to extend the coverage to remote and rural areas
- ◆ Contain all Gigabit interfaces, including Ethernet and Wi-Fi
- ◆ IP67, Surge, and ESD protection
- ◆ Lightweight, compact and unobtrusive design
- ◆ Easy installation with PoE support
- ◆ Enterprise-class secure VPN connections, IPSec, OpenVPN, GRE, PPTP, L2TP
- ◆ Remote management with Billion CMS



Simultaneous Dual-Band Wireless up to 2000Mbps

Concurrent dual-band 802.11a/n/ac(5GHz) and 802.11b/g/n(2.4GHz) Wireless LAN, allowing for Wi-Fi Hotspot functionality anywhere there is cellular signal.



Instant Outdoor Hotspot setup with Outdoor LTE Wi-Fi Router

BiPAC 4700AZ integrate the 4G LTE and Wi-Fi technology, providing instant high-performance LTE connectivity to outside harsh environments Wi-Fi Hotspot applications.

Key Features

1. Provide mobile Wi-Fi access in the outdoor environment.
2. The box is water-proofed and hard solid without cracking
3. Unique antenna design helps to extend the LTE service coverage
4. Support authentication and advertisement with Wi-Fi hotspot customizable captive portal design
5. Setup quickly and easily mount onto poles

HotSpot
Welcome to my HotSpot!

Username

Password



Wi-Fi



LTE



Tower

Supports Power over Ethernet (PoE)



Outdoor LTE
Dual-Band Wi-Fi Hotspot Router

Instant POS Setup for Credit Card Access in Remote Area

Billion LTE outdoor router series can provide a robust LTE connection, enabling instant POS setup for credit card access in remote areas where there is no fixed-line Internet connection. Because of different local legislations, the POS system may need to be set up an Internet connection with the banks. BiPAC 4700ZU can establish a VPN connection with the central business unit where the main company server is located to process the transaction seamlessly.



LTE Outdoor Routers

4700AZ



LTE Outdoor VPN Router with Carrier-Grade Dual-Band Wi-Fi Hotspot

4700ZU



LTE Outdoor VPN Router

4700ZUL



LTE Outdoor Router

4600



LTE Outdoor VPN Router

WAN Interface	4700AZ	4700ZU	4700ZUL	4600
LTE	●	●	●	●
Ethernet WAN	● (GbE) (*1)	-	-	-
Hardware Interface	4700AZ	4700ZU	4700ZUL	4600
SIM slot	● (x1)	● (x1)	● (x1)	● (x1)
Gigabit Ethernet	● (x2) (Configurable EWAN x1)	● (x1)	● (x1)	● (x1)
802.11n(2.4GHz)	● (300 Mbps (2x2))	-	-	-
802.11ac(5 GHz)	● (1700 Mbps (4x4))	-	-	-
PoE-PD	●	●	●	●
Features	4700AZ	4700ZU	4700ZUL	4600
IPv4 / IPv6	●	●	●	●
Dual APN	● (*2)	● (*2)	● (*2)	● (*2)
Dual-WAN (Failover/Failback)	●	-	-	-
Dual-WAN (Load Balance)	●	-	-	-
Interface Grouping	●	-	-	-
VPN	●	●	-	●
Hotspot	●	-	-	-
IP67	●	●	●	●
Operating temperature	-40°C - 60 °C	-40°C - 60 °C	-40°C - 60 °C	-40°C - 60 °C

*1: Software configurable EWAN.

*2: Dual APNs is only upon request for Telco/ ISP tender projects.

LTE represents the 4th generation of broadband cellular network technology, providing outstanding transmission efficiency and broadband service coverage.

Especially LTE can be used to offer Fixed-Wireless-Broadband services. The LTE Fixed-Wireless-Broadband market was valued at USD 22.3 billion in 2019 and is expected to reach USD 81.4 billion by 2025, at a CAGR of 24.5% over the 2020~2025 period.

Billion provides a variety of LTE products, creating superior solutions for in-house or outdoor environments, maintaining strong network connectivity in the served area, and enabling service providers and system integrators to build comprehensive applications and long-term winning business models to explore potential business opportunities and generate revenue.

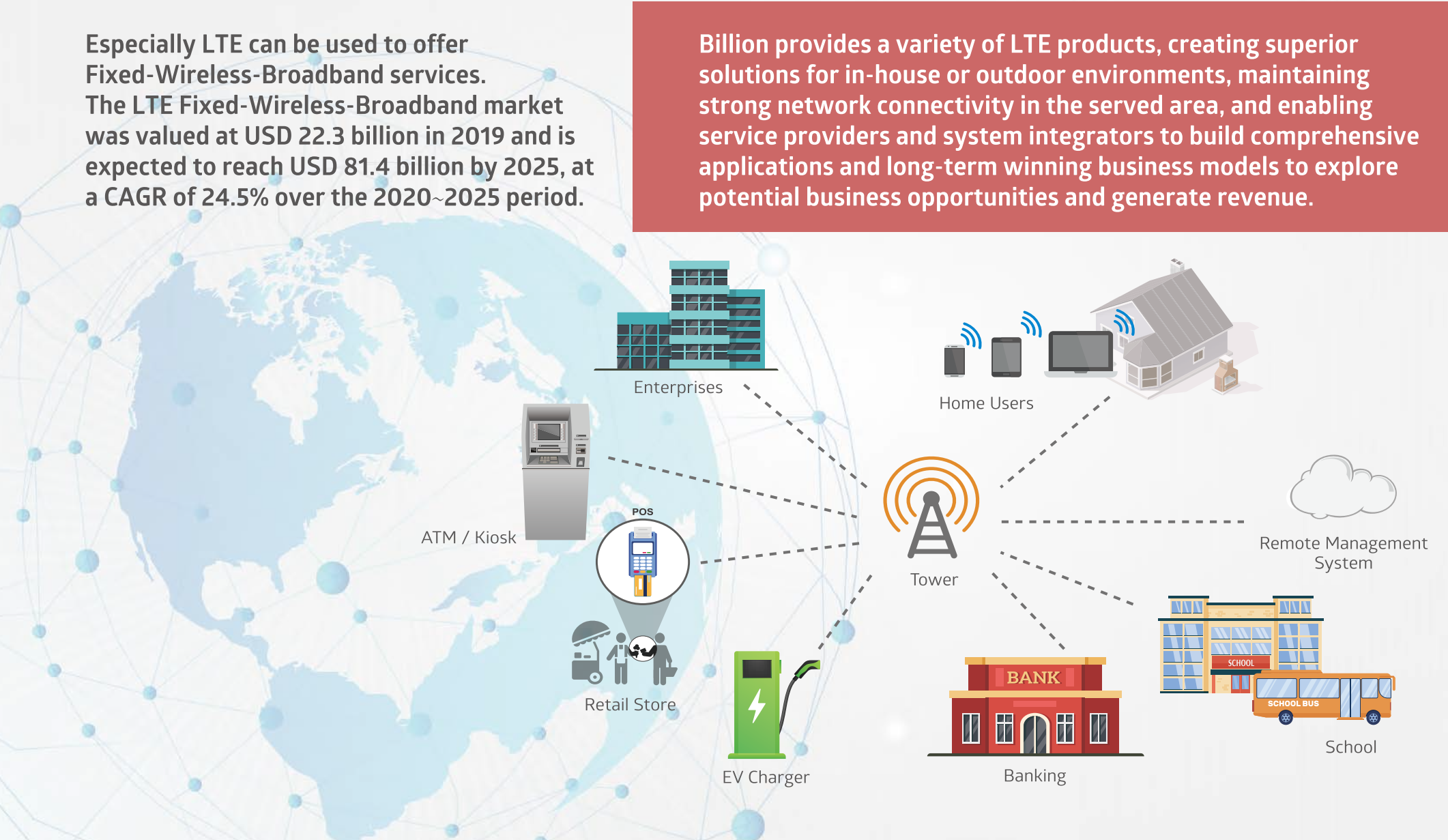

Features and Benefits



High-Performance Security VPN



High Availability and Network Redundancy



Advanced Antenna Technology



Multiple LTE Band Support



Integrate VoIP and Advanced Call Features



IPv6, The Path to the Future



Wi-Fi Hotspot



LTE Outdoor in Challenging Rugged Environment



Billion Central Management System (Billion CMS) Support

Applications and Solutions



POS for Credit Card Access in Remote Area



Multiple VPN Solutions (IPSec, OpenVPN, GRE ...)



SCADA over VPN Tunnel with LTE Backup



Dual WAN (EWAN / LTE) Failover/Failback



Instant Outdoor Wi-Fi Hotspot with Dual WAN



Billion Central Management System (Billion CMS) for Remote Monitoring and Management

Indoor LTE Routers

4520VAOZ R3



LTE Dual-SIM VoIP
Wi-Fi 5 AC 2400
VPN Firewall Router

4520AZ R3



LTE Dual-SIM
Wi-Fi 5 AC 2400
VPN Firewall Router

4500VAOZ R3



LTE VoIP
Wi-Fi 5 AC 2400
VPN Firewall Router

4500AZ R3



LTE
Wi-Fi 5 AC 2400
VPN Firewall Router

WAN Interface	4520VAOZ R3	4520AZ R3	4500VAOZ R3	4500AZ R3
LTE	●	●	●	●
Ethernet WAN	● (GbE) (*1)	● (GbE) (*1)	● (GbE) (*1)	● (GbE) (*1)
Hardware Interface				
SIM slot	● (x2)	● (x2)	● (x1)	● (x1)
Gigabit Ethernet	● (x4) (Configurable EWAN x1)	● (x4) (Configurable EWAN x1)	● (x4) (Configurable EWAN x1)	● (x4) (Configurable EWAN x1)
802.11n (2.4GHz)	● (600 Mbps (3x3))	● (600 Mbps (3x3))	● (600 Mbps (3x3))	● (600 Mbps (3x3))
802.11ac (5GHz)	● (1733 Mbps (4x4))	● (1733 Mbps (4x4))	● (1733 Mbps (4x4))	● (1733 Mbps (4x4))
USB Host	● (USB 2.0)	● (USB 2.0)	● (USB 2.0)	● (USB 2.0)
FXS	● (x2)	-	● (x2)	-
Features				
VPN	●	●	●	●
Dual APN	● (*2)	● (*2)	● (*2)	● (*2)
Dual WAN (Failover/Failback)	●	●	●	●
Dual WAN (Load Balance)	●	●	●	●
Interface Grouping	●	●	●	●
IPv4 / IPv6	●	●	●	●

*1: Software configurable EWAN.

*2: Dual APNs is only upon request for Telco/ ISP tender projects.

Indoor LTE Routers

4520VNO(P)Z R2



LTE Dual-SIM VoIP
Wireless-N (VPN)
Firewall Router

4520NZ(L) R2



LTE Dual-SIM
Wireless-N (VPN)
Firewall Router

4500VNO(P)Z R2



LTE VoIP
Wireless-N(VPN)
Firewall Router

4500NZ(L) R2



LTE
Wireless-N(VPN)
Firewall Router

WAN Interface	4520VNO(P)Z R2	4520NZ(L) R2	4500VNO(P)Z R2	4500NZ(L) R2
LTE	●	●	●	●
Ethernet WAN	● (GbE) (*1)	● (GbE) (*1)	● (GbE) (*1)	● (GbE) (*1)
Hardware Interface				
SIM slot	● (x2)	● (x2)	● (x1)	● (x1)
Gigabit Ethernet	● (x4) (Configurable EWAN x1)	● (x4) (Configurable EWAN x1)	● (x4) (Configurable EWAN x1)	● (x4) (Configurable EWAN x1)
802.11n (2.4GHz)	● (300 Mbps (2x2))	● (300 Mbps (2x2))	● (300 Mbps (2x2))	● (300 Mbps (2x2))
802.11ac (5GHz)	-	-	-	-
USB Host	● (USB 2.0)	● (USB 2.0)	● (USB 2.0)	● (USB 2.0)
FXS	● (x2)	-	● (x2)	-
Features				
VPN	● (4520VNOZ R2 only)	● (4520NZ R2 only)	● (4500VNOZ R2 only)	● (4500NZ R2 only)
Dual APN	● (*2)	● (*2)	● (*2)	● (*2)
Dual WAN (Failover/Failback)	●	●	●	●
Dual WAN (Load Balance)	●	●	●	●
Interface Grouping	●	●	●	●
IPv4 / IPv6	●	●	●	●

*1: Software configurable EWAN.

*2: Dual APNs is only upon request for Telco/ ISP tender projects.



BILLION[®]

**CONSISTENT QUALITY
REDUCE HIDDEN COSTS**

Our DSL products are designed to meet the critical demands of SOHO and SMB business users by featuring superior uplink/downlink rates and rich Firewall, VPN, QoS, and failover/failback capabilities. With the integrated latest Wi-Fi technologies such as Wi-Fi 5 or 6, Wi-Fi clients could easily and conveniently access the Internet.

We offer rich Firewall security such as SPI, and DoS defense to against fraudulent Internet attack and hacker threats, thereby ensuring the highest confidentiality to protect digital information and intellectual property. Quality of Service (QoS) and VLAN enable fast HD video streaming, music downloading, online gaming, file sharing, and other large bandwidth-consuming applications. Failover/Failback capability to ensure the connectivity is always ON.

Therefore, our DSL solutions are extremely cost-effective with reliable and secured connectivity to guarantee the quality of broadband service.

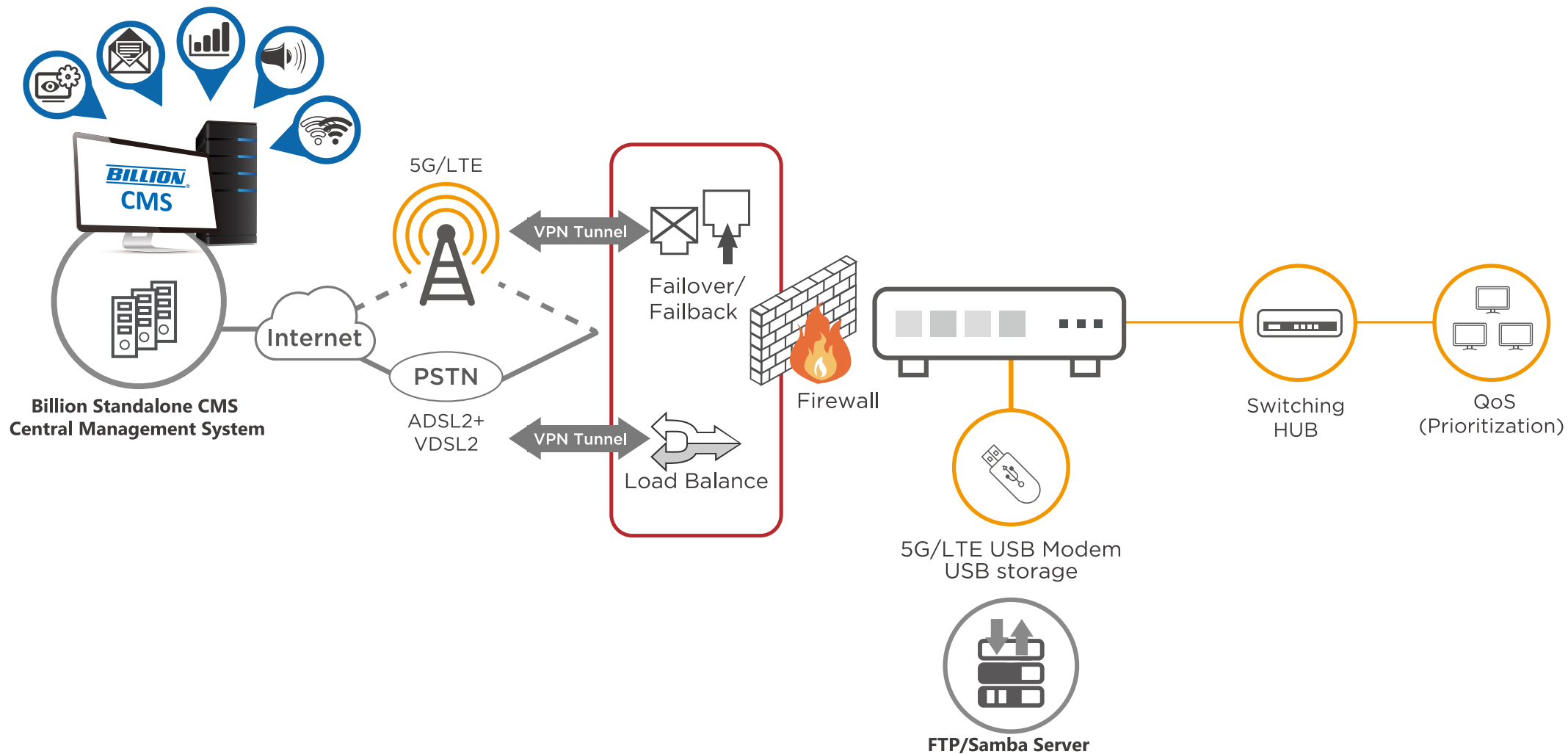

DSL Routers



BiPAC 8900X R3
LTE VDSL2/ADSL2+ VPN Firewall Router

WAN Interface	
LTE	● (via USB)
Ethernet WAN	● GbE(*1)
V/ADSL	●
Hardware Interface	
Gigabit Ethernet	● (x4) (Configurable EWAN x1)
USB Host	● (USB 2.0 x1)
Features	
VPN	●
IPv4 / IPv6	●
VLAN MUX	●
Dual WAN (Failover / Failback)	●
Dual WAN (Load Balance)	●

*1: Software configurable EWAN.

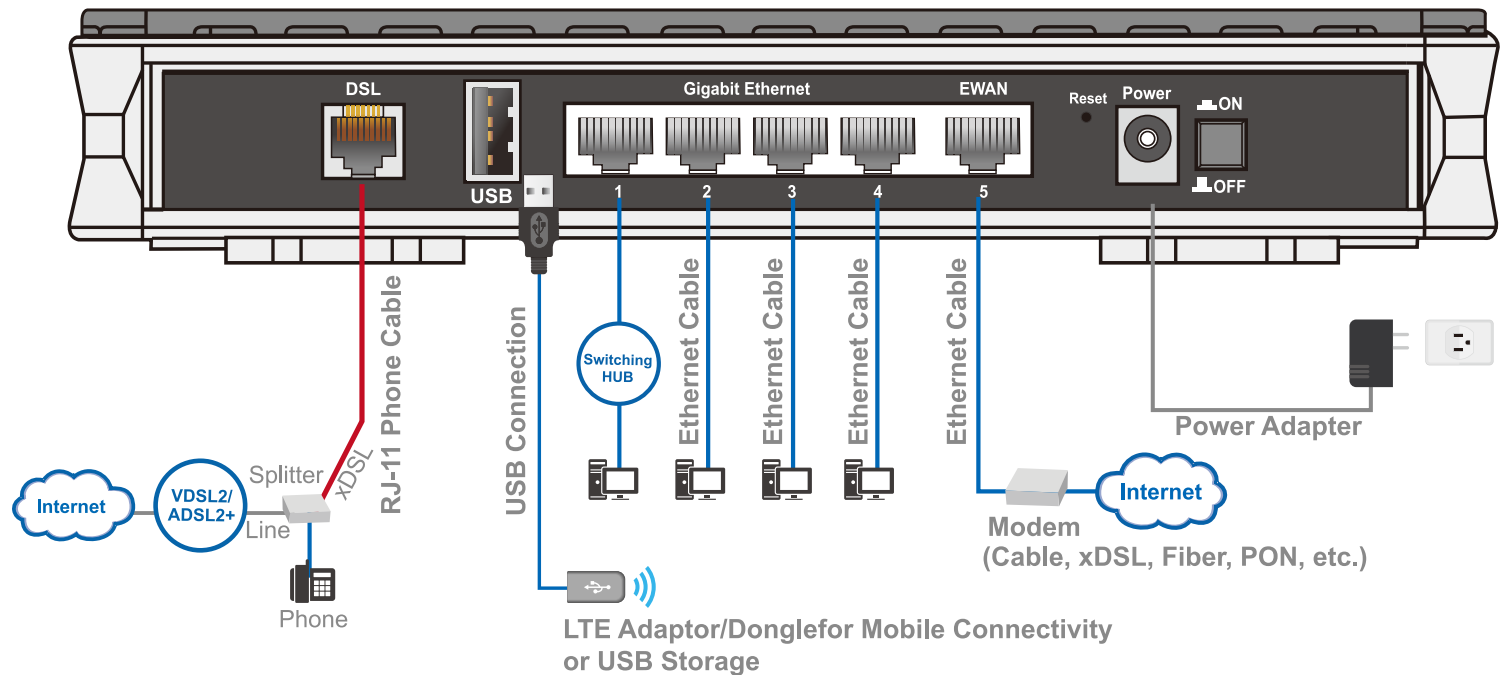

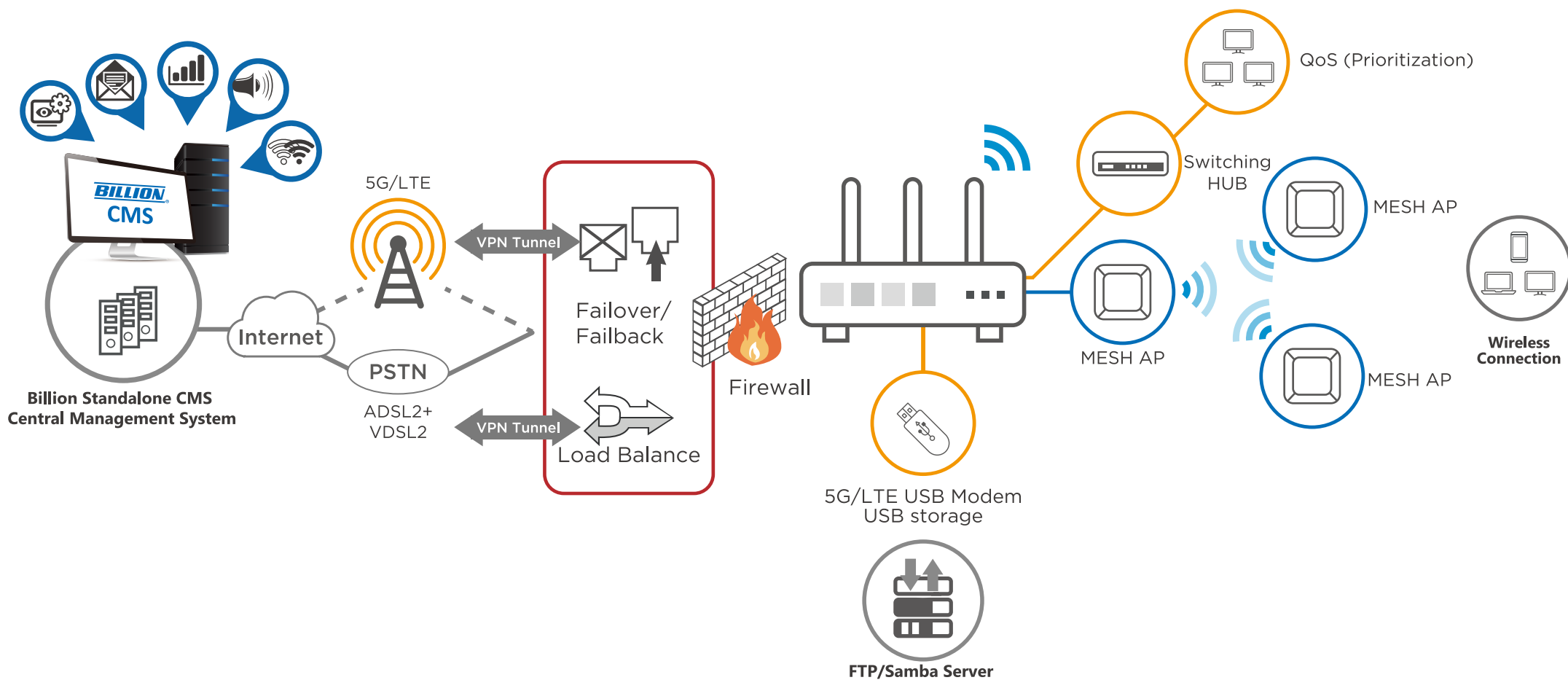

Wireless AP Routers

8207AZ



5G/LTE Embedded
V/ADSL2+ Wi-Fi 6 AX 1500
VPN Firewall Router

8206AZ



LTE Embedded
V/ADSL2+ Wi-Fi 5 AC 1200
VPN Firewall Router

8200AXL-1200



Triple-WAN Wi-Fi 5 AC 1200
LTE and VDSL2/ADSL2+
Firewall Router

WAN Interface			
LTE	● (5G/LTE)	●	● (via USB)
Ethernet WAN	● (GbE) (*1)	● (*1)	● (GbE) (*1)
V/ADSL	●	●	●
Hardware Interface			
SIM slot	● (x1)	● (x1)	-
Gigabit Ethernet	● (x4) (Configurable EWAN x1)	● (x5) (Configurable EWAN x1)	● (x4) (Configurable EWAN x1)
USB Host	● (USB 2.0 x1)	● (USB 2.0 x1)	● (USB 2.0x1 and USB 3.0x1)
802.11n (2.4 GHz)	● (300Mbps)	● (300Mbps)	● (300Mbps)
802.11ac (5 GHz)	-	● (867Mbps(2x2))	● (867Mbps(2x2))
802.11ax (5 GHz)	● (1200Mbps(2x2))	-	-
Features			
VPN	●	●	-
IPv4 / IPv6	●	●	●
VLAN MUX	●	●	●
Dual WAN (Failover / Failback)	●	●	●
Dual WAN (Load Balance)	●	●	●

*1: Software configurable EWAN.

Wireless AP Routers

8700NEXL R2



Wireless-N
VDSL2/ADSL2+
Firewall Router

8700NEXL R3



Wireless-N
VDSL2/ADSL2+
Firewall Router

8700AXL-1600



Triple-WAN Wireless
1600Mbps
LTE and VDSL2/ADSL2+
Firewall Router

WAN Interface			
LTE	● (via USB)	● (via USB)	● (via USB)
Ethernet WAN	● (GbE)	● (GbE)	● (GbE)
V/ADSL	●	●	●
Hardware Interface			
SIM slot	-	-	-
Fast Ethernet	● (x4)	● (x4)	-
Gigabit Ethernet	●(x1) (for EWAN LAN5)	● (x1) (for EWAN LAN5)	● (x5)
USB Host	● (USB 2.0 x1)	● (USB 2.0 x1)	● (USB 2.0 x1)
802.11n (2.4 GHz)	● (300Mbps)	● (300Mbps)	● (300Mbps)
802.11ac (5 GHz)	-	-	● (1300Mbps(3x3))
Features			
VPN	-	-	-
IPv4 / IPv6	●	●	●
VLAN MUX	●	●	●
Dual WAN (Failover / Failback)	●	●	●
Dual WAN (Load Balance)	-	-	-

Wireless AP Routers

8900AX-1600 R2



Wireless 1600Mbps
LTE and VDSL2/ADSL2+
VPN Firewall Router

8900AX-2400



Wireless-AC 2400Mbps
LTE VDSL2/ADSL2+
VPN Firewall Router

BiPAC 8920AXL



Bonded VDSL2 with
Triple-WAN Wireless 1600Mbps,
LTE and VDSL2/ADSL2+
Firewall Router

WAN Interface			
LTE	● (via USB)	● (via USB)	● (via USB)
Ethernet WAN	● (GbE)	● (GbE)	● (GbE)
V/ADSL	●	●	●
Hardware Interface			
SIM slot	-	-	-
Fast Ethernet	-	-	-
Gigabit Ethernet	● (x5)	● (x4)	● (x4)
USB Host	● (USB 2.0 x1)	● (USB 2.0 x1)	● (USB 2.0 x1)
802.11n (2.4 GHz)	● (300Mbps)	● (600Mbps (3x3, high power))	● (300Mbps)
802.11ac (5 GHz)	● (1300Mbps(3x3))	● (1750Mbps (4x4))	● (1300Mbps(3x3))
Features			
VPN	●	●	-
IPv4 / IPv6	●	●	●
VLAN MUX	●	●	●
Dual WAN (Failover / Failback)	●	●	●
Dual WAN (Load Balance)	●	●	●

VoIP (Voice-over-Internet-Protocols), bringing voice over the Internet instead of regular phone lines, benefits service providers and subscribers to offer cost-effective local or long distance call even calling to mobile or international numbers.

However, since VoIP data encounters a soaring risk of being intercepted by hackers, most VoIP users are in need of reliable network protection that can build an encrypted tunnel for VoIP data transmission.

To solve the threatening security issues, we offer rich VPN (Virtual-Private-Network) features to strengthen the connectivity and to secure transmission privacy between two sites such as headquarter and branch offices.

Manageable devices

Best bandwidth usage

Always on secure connection

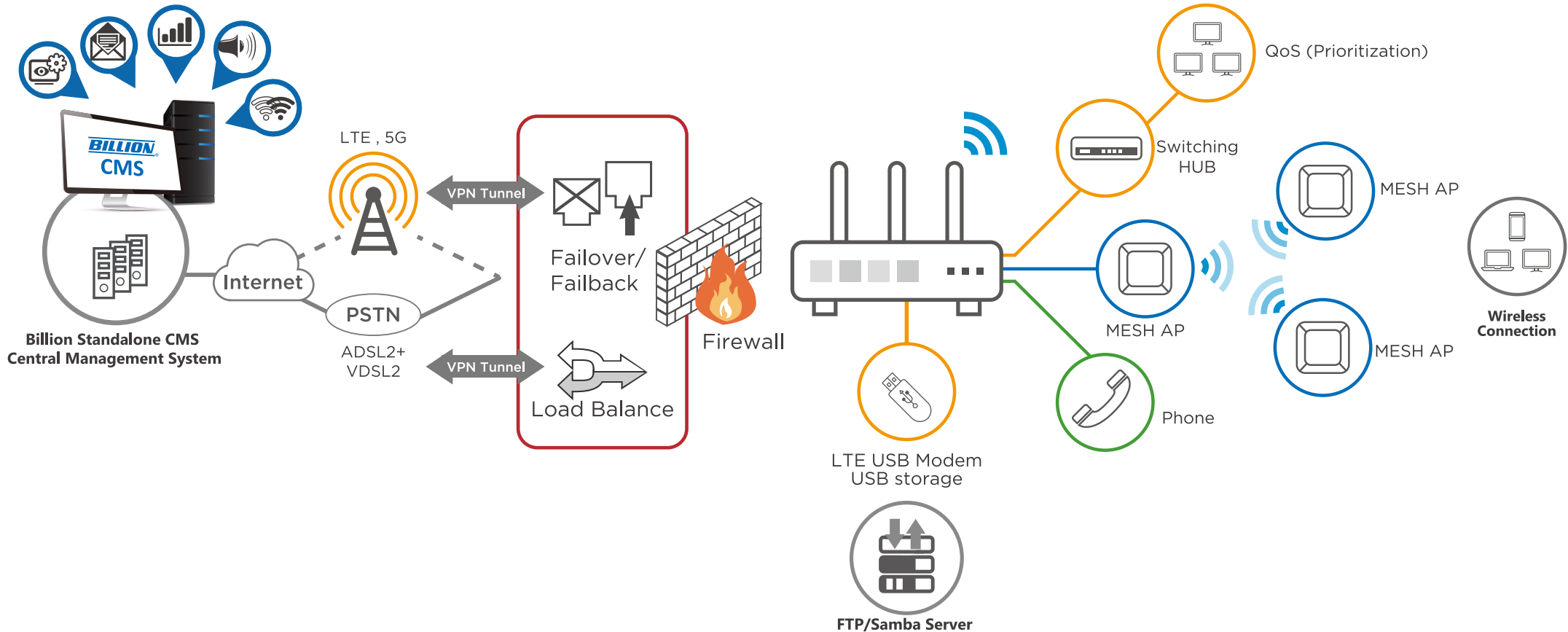

With the failover and failback capability, voice providers can provide a secure, high speed internet to back up the connection in case of any network failure. We support common voice settings like call forwarding, call waiting, conference call, anonymous call, block anonymous call, speed dial, return call, and redial, ..etc, as well as advanced local SIP port setting to resolve any blocking problems. Customizable features and interfaces can be modified, enabling voice providers to offer high-quality, user-friendly network solutions to their customers.

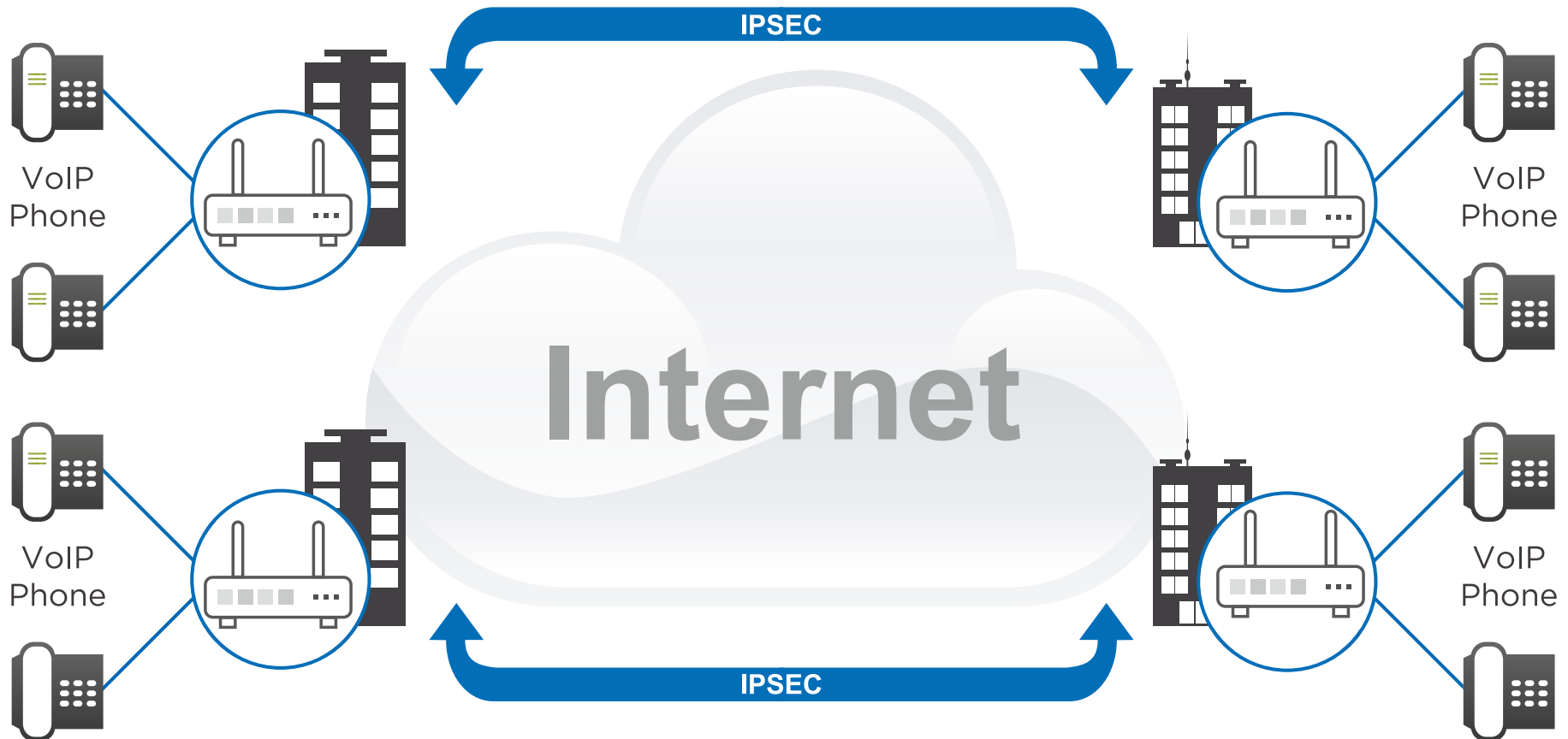

Wireless AP VoIP Routers

8207VAZ



5G/LTE Embedded
V/ADSL2+ Wi-Fi 6 AX 1500
VoIP VPN Firewall Router

8700VAXL-1600



Triple-WAN Wireless-1600Mbps
LTE and VDSL2/ADSL2+
VoIP Router

WAN Interface	8207VAZ	8700VAXL-1600
5G/LTE	● (5G/LTE)	● (via USB)
Ethernet WAN	● (GbE) (*1)	● (GbE) (*1)
V/ADSL	●	●
Hardware Interface		
SIM slot	● (x1)	-
Gigabit Ethernet	● (x4) (Configurable EWAN x1)	● (x4) (Configurable EWAN x1)
USB Host	● (USB 2.0 x1)	● (USB 2.0 x1)
FXS	● (x1)	● (x2)
802.11n (2.4 GHz)	● (300Mbps)	● (300Mbps)
802.11ac (5 GHz)	-	● (1300Mbps(3x3))
802.11ax (5 GHz)	● (1200Mbps(2x2))	-
Features		
VPN	●	-
IPv4 / IPv6	●	●
VLAN MUX	●	●
Dual WAN (Failover / Failback)	●	●
Dual WAN (Load Balance)	●	-

*1: Software configurable EWAN.

■ Complete Active Ethernet FTTH Last-Mile Access Solutions

Active Ethernet FTTH Solutions Last-Mile Access Solutions for Telco/ISP

We provide Active Ethernet Point-to-Point fiber router for Telco/ISP to deploy Giga wired-speed FTTH for last-mile access applications at residential and commercial areas.

Unique Features



A Giga wired-speed connection from CO site to home user



Establishes secure VPN connection from branch offices to headquarters

■ AE FTTH Solution for Home Users

A Complete AE (Active Ethernet) FTTH Solution for ISP/Telco to Provide Giga Wired-Speed FTTH Applications to Home Users

Through its Giga fiber connection ports, end users can connect with Billion Giga AE fiber router and enjoy more cost-effective, faster, and safer Giga wired-speed FTTH applications.

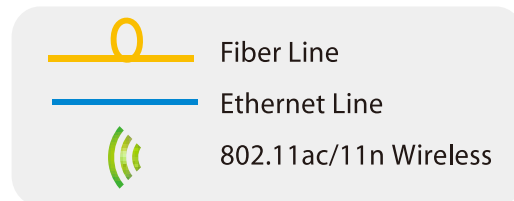
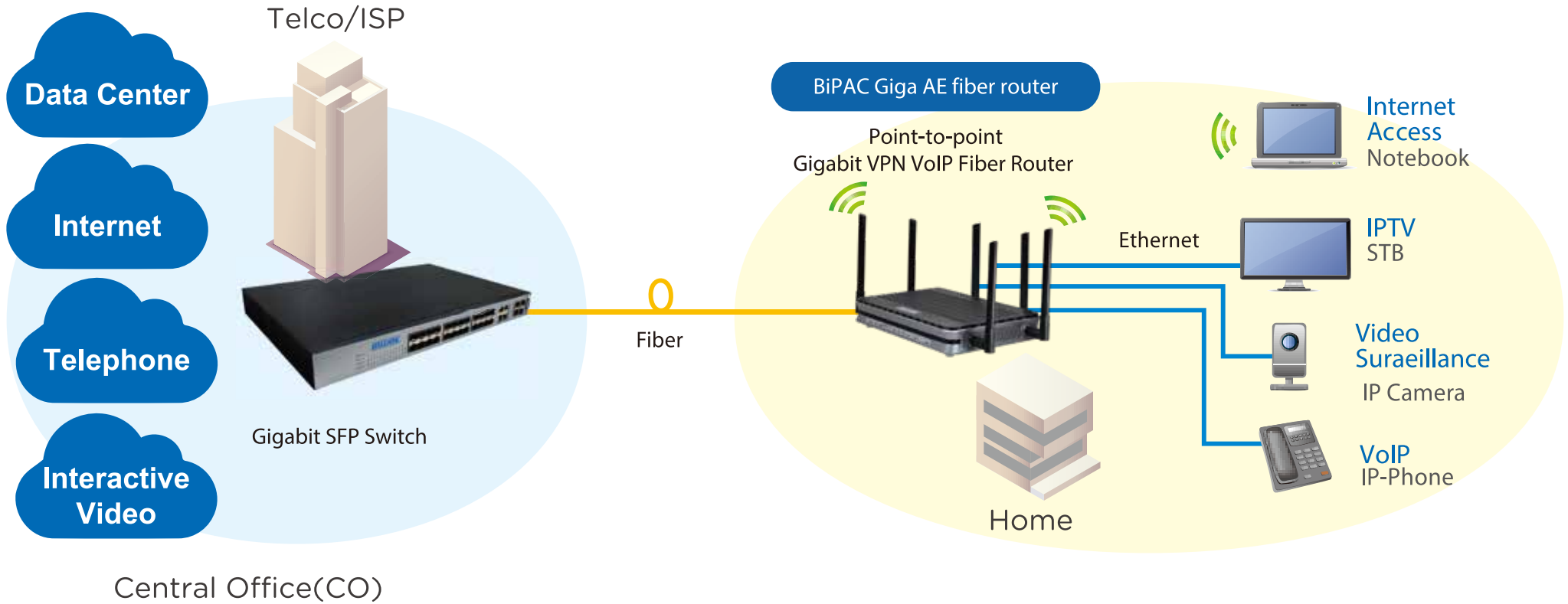

Application of High Density Communities

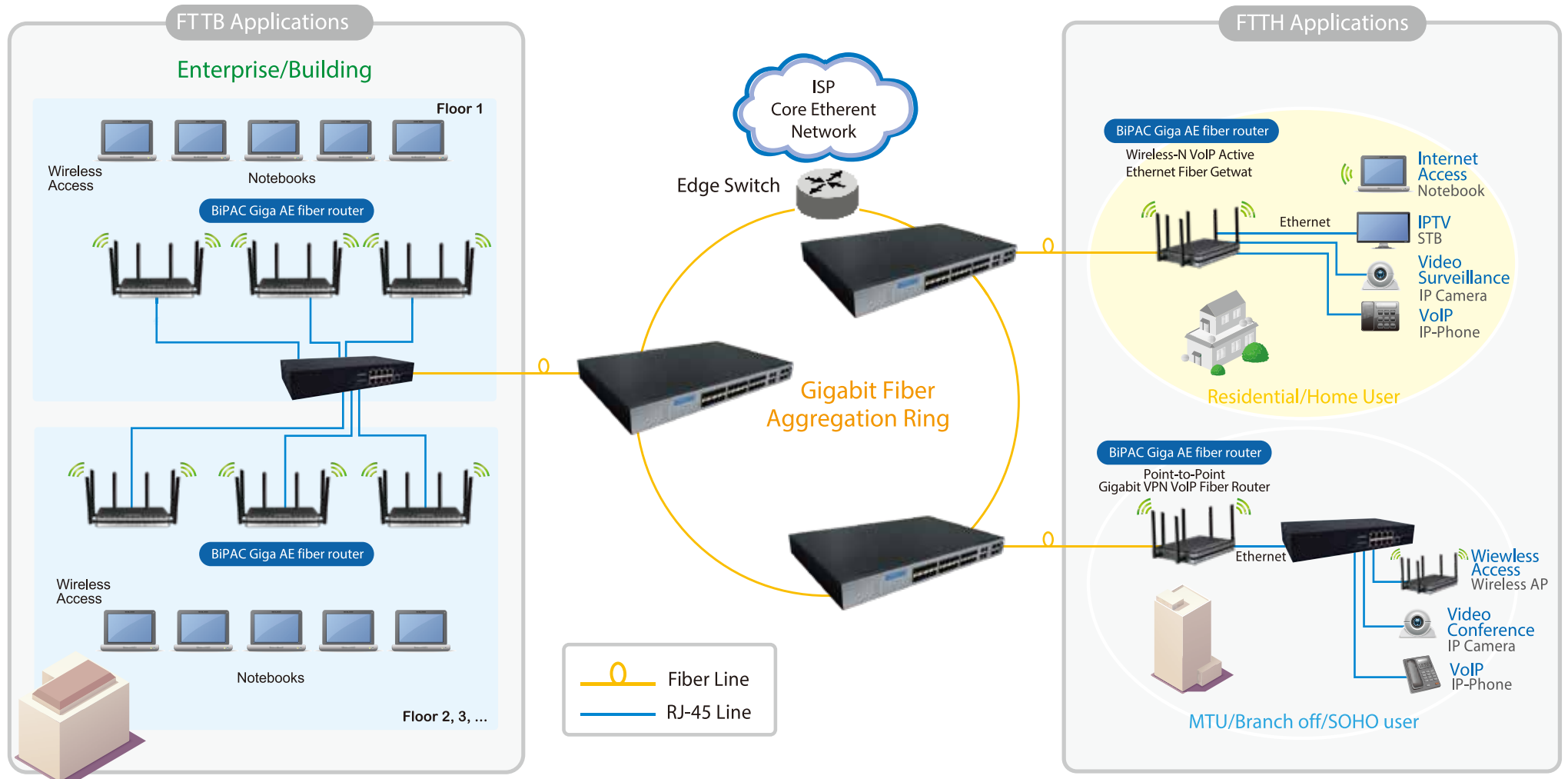

P2P
Fiber
Routers

9900VA



Dual-Band Wireless
Active Ethernet Point-to-Point
VoIP VPN Gateway

WAN Interface	
P2P GbE Fiber (SFP)	●
Ethernet WAN	● (GbE) (*1)
Hardware Interface	
Gigabit Ethernet	● (x3) (Configurable EWAN x1)
USB Host	● (USB 2.0 x1)
FXS	● (x2)
802.11n(2.4 GHz)	● (300Mbps)
802.11ac(5 GHz)	● (1700Mbps)
Features	
VPN	●
IPv4 / IPv6	●
Dual WAN (Failover / Failback)	●

*1: Software configurable EWAN.

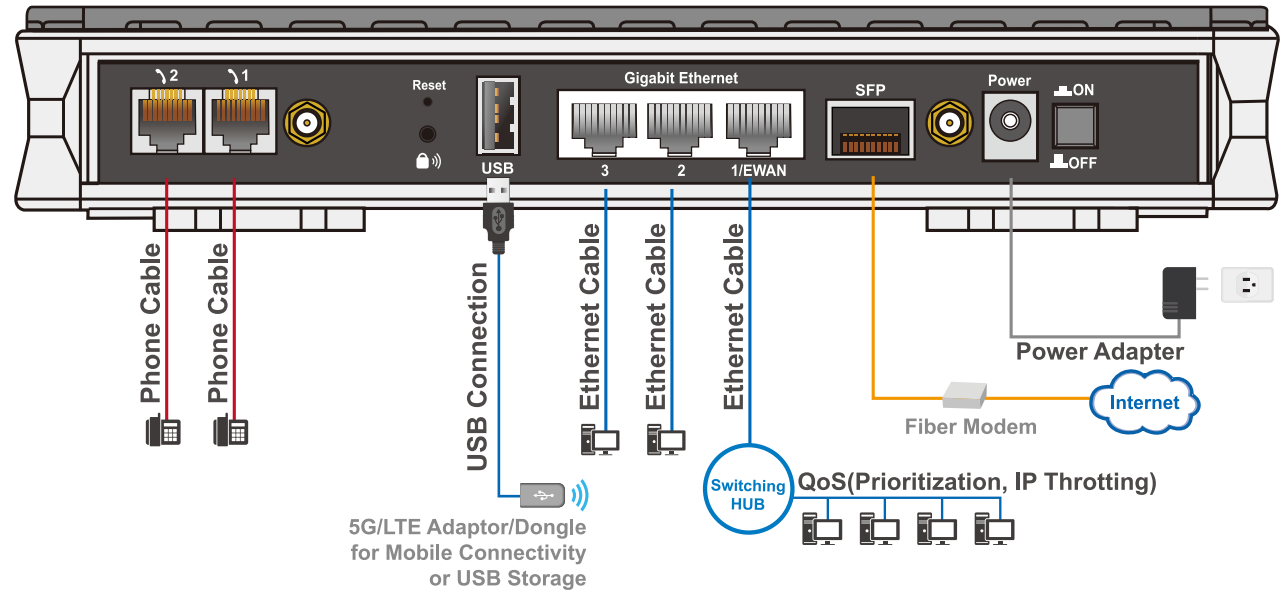

About BILLION

Billion Electric Co., Ltd. (Taiex: 3027, trading as Billion) is a leading global information and communication technology (ICT) solutions provider. We enhance life and communication efficiency through a better-connected world, acting as a responsible corporate citizen, an innovative enabler for the information society, and a collaborative contributor to the industry. Billion is dedicated to creating optimal value for telecom operators and determined to pursue the position of industry vanguard by providing our current and future customers the highest quality of technology outputs.

www.billion.com

Billion Electric Co., Ltd. Taiwan- HQ

8F, No.192, Sec. 2, Zhongxing Rd., Xindian Dist.,
New Taipei City 23146, Taiwan, R.O.C.
TEL : +886-2-2914-5665
FAX : +886-2-2918-2895
E-mail : marketing@billion.com

BEC Technologies, Inc. USA

Central Region Headquarters
3301 Matrix Drive, Suite 200,
Richardson, TX 75082
USA
TEL : +1-972-422-0877
FAX : +1-972-422-0886
E-mail : marketing@billion.com

Networking Communication Product Portfolio



BILLION[®]

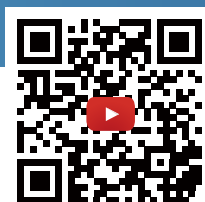

www.billion.com