

Billion

BIPAC-221

USB ISDN TA with 2 Analog Ports

Quick Start Guide

This product is designed for the ISDN with Basic Rate Interface.

Package Contents

- One external USB ISDN TA with 2 analog ports
- One installation CD with drivers and utility software
- One CD with bundled application software programs (optional)
- One RJ-45 ISDN cable
- One USB cable
- One power adapter
- This Quick Start Guide

The Front Panel LEDs

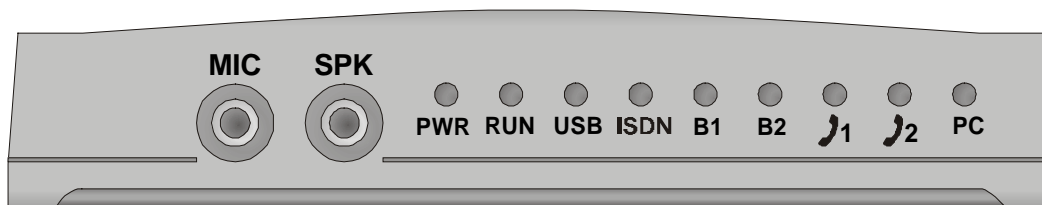

LED	Meaning
PWR	When lit, it indicates the power adapter is connected.
RUN	Flashes periodically to indicate that the USB ISDN TA is working properly.
USB	When lit, it indicates the USB port is connected to the PC. When flashing, it indicates the USB is on download status.
ISDN	When lit, it indicates that the ISDN S ₀ bus is activated.
B1	When lit, it indicates that the ISDN “B1” channel is being accessed. It will flash during data transfer.
B2	When lit, it indicates that the ISDN “B2” channel is being accessed. It will flash during data transfer.
Phone 1	When lit, it indicates that the analog device connected to the Phone 1 port is in use.
Phone 2	When lit, it indicates that the analog device connected to the Phone 2 port is in use.
PC	When lit, it indicates that at least one application program running on the PC is using the USB ISDN TA.

Installing the BIPAC-221

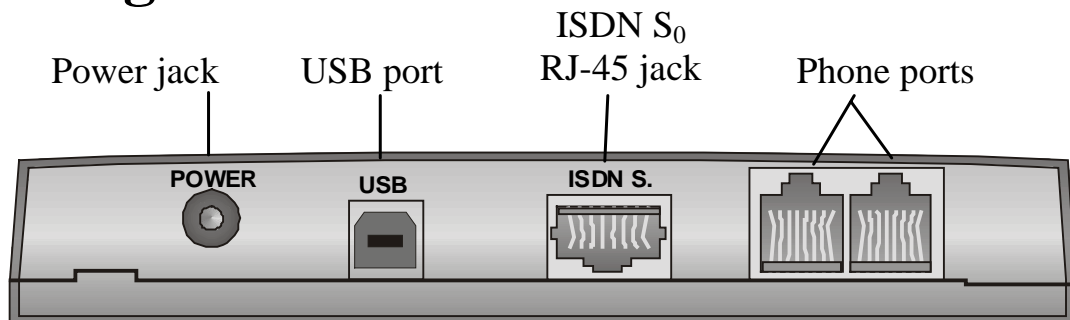

1. Connect the external power adapter to the power jack. All the LEDs light and then go off one by one, except that the PWR LED will still light.
2. Connect your ISDN line to the ISDN S₀ RJ-45 jack.
3. Connect your analog telephone and/or G3 fax machine to the phone ports.
4. Connect a headset to the “MIC/SPK” jacks.
5. Connect the USB cable to the USB port and connect the other end to the PC.

For Windows 98:

1. Start Windows. After the opening banner, Windows will tell you that the new device has been detected. You will then see the following screen. Click “Next >”.



2. In the next window, select “Search for the best driver for your device” and click “Next >”.



3. Insert the installation CD into the CD-ROM drive and check “CD-ROM drive” in the next window.



4. Continue through the Wizard, clicking the “Next >” buttons. Windows will start copying files to your system. You will see the following screen prompting for the path of the Windows source files. Please specify a location. Click “OK”. Then, click “Finish” in the next window to end the installation.

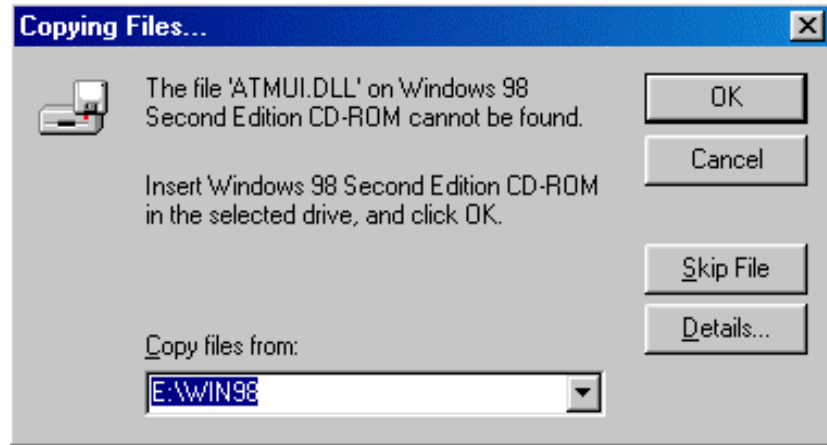

5. If you are prompted to restart the computer after Windows finishes installing the driver, press “Yes”.

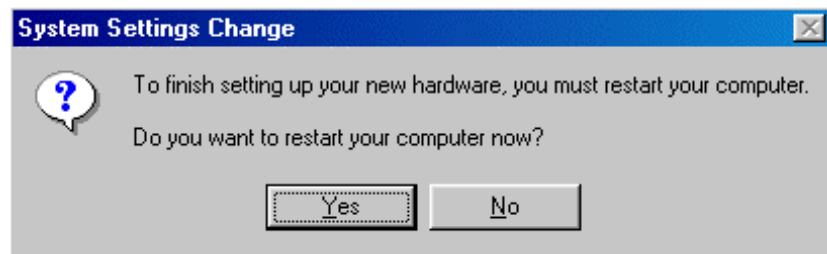

For Windows Me:

1. Start Windows. After the opening banner, Windows will tell you that the new device has been detected. Select “Specify the location of the driver” and click “Next >”.



2. In next window, select “Search for the best driver for your device”. Insert the installation CD into the CD-ROM drive and check “Removable Media”. Click the “Next >” button.

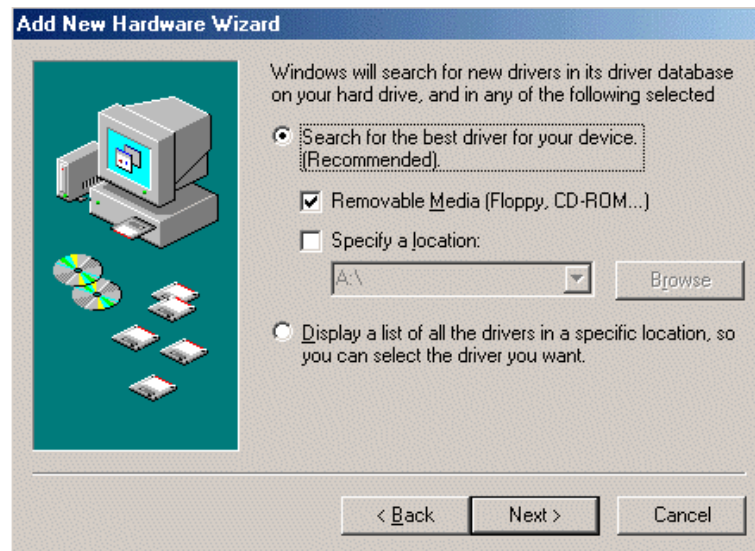

3. Continue through the Wizard, clicking “Next >” at the following screens. Windows will start copying files to your system. Then, click “Finish” in the following window.



4. If you are prompted to restart the computer after Windows finishes installing the drivers, press “Yes”.

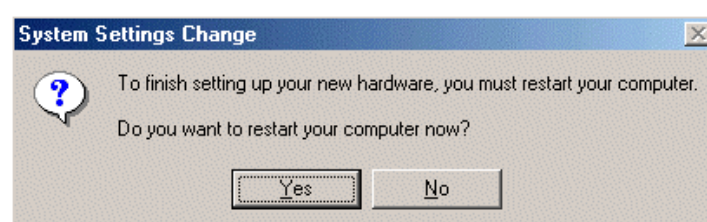

For Windows 2000:

1. Start Windows. After the opening banner, Windows will tell you that the new device has been detected. Click “Next>”.



2. In next window, select “Search for a suitable driver for my device”. Click “Next>”.



3. Insert the installation CD into the CD-ROM drive, then in the next window check “CD-ROM drives” and click “Next>”.



4. Click “Next>” to install the driver. When the following windows titled “Digital Signature Not Found” appear, press “Yes” to continue the installation.

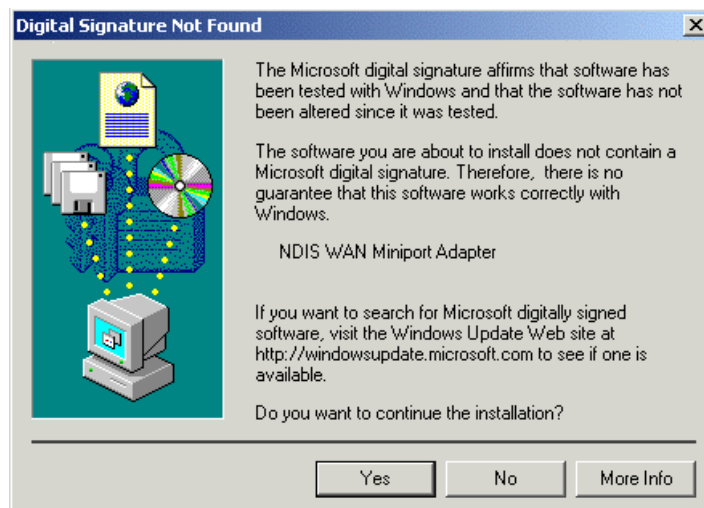
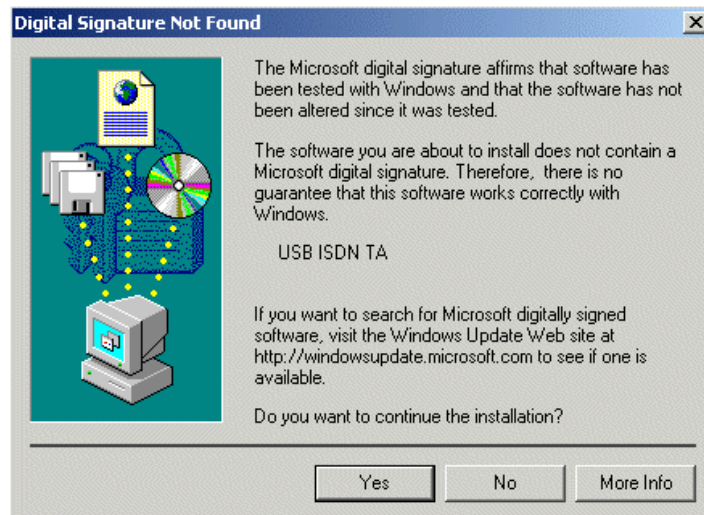

5. Press “Finish” to end the installation.

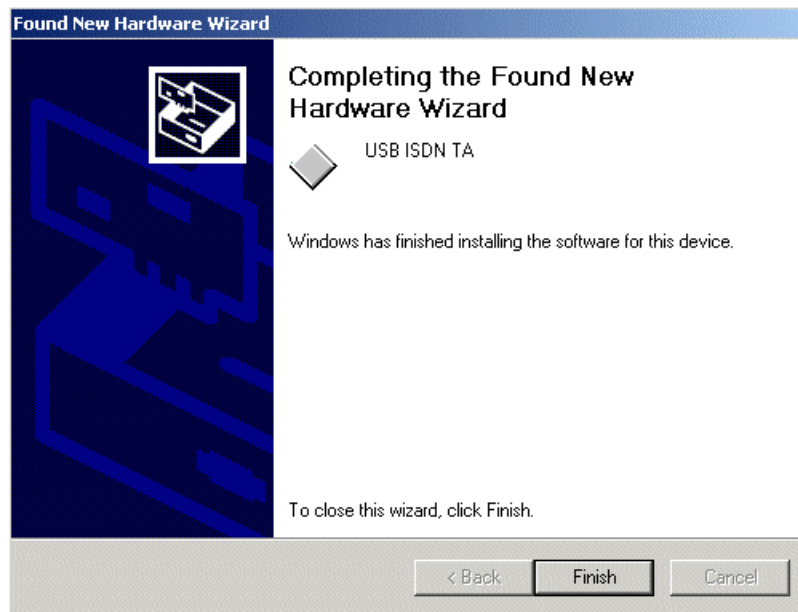

For Windows XP:

1. Start Windows. After the opening banner, Windows will tell you that the new device has been detected. Select “Install the software automatically”. Insert the installation CD into the CD-ROM drive and click “Next >”.



2. When next window appears, press “Next >” to continue the installation.

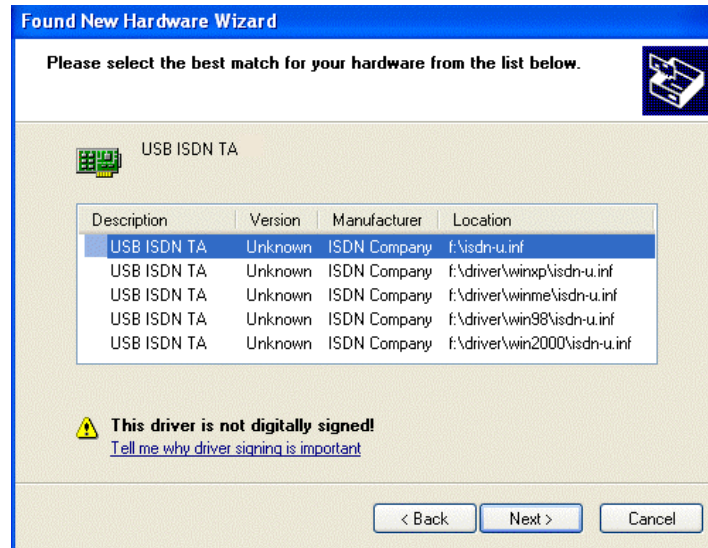

3. Click “Continue Anyway” when the following “Hardware Installation” windows appear.



4. Press “Finish” to end the installation.

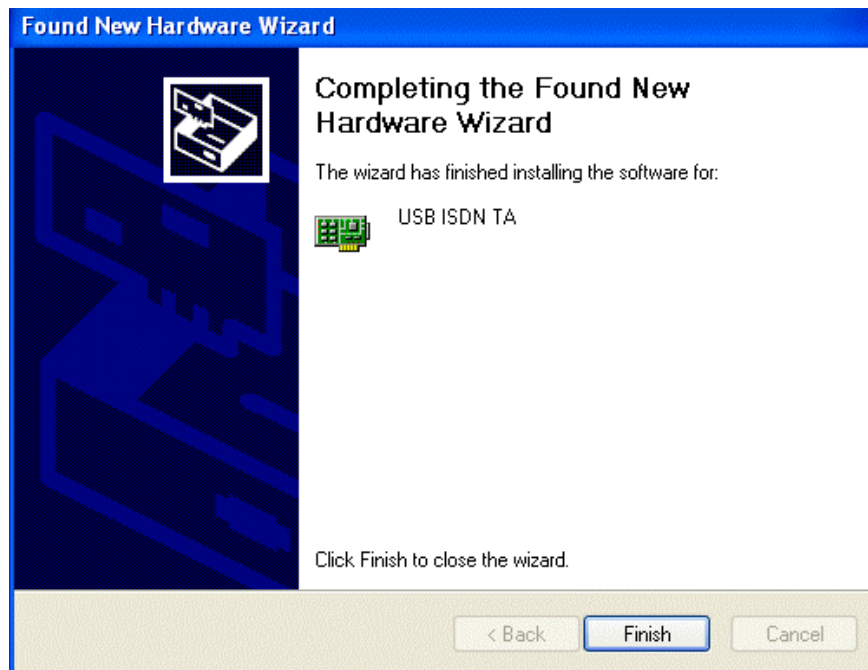

ISDN Utility and Diagnostic Program

The ISDN Utility includes helpful programs for the USB ISDN TA, such as a diagnostic program, an uninstallation program, and an on-line manual.

After Windows installs the driver of your ISDN TA, the ISDN Utility may be installed automatically. If the ISDN Utility is not installed, you may install it from the installation CD.

You are highly recommended to run the diagnostic program to make sure the USB ISDN TA, its drivers and the ISDN line are all properly installed and connected. Please follow these instructions:

1. Open the “Programs” folder on the “Start” menu and click on the “ISDN Utility” program folder.
2. Click on the “Diagnostic Program” item to start the program.
3. In the “Own ISDN Number” box, type in the subscriber number of your ISDN line.

4. Press “Loopback Test” to begin the diagnostic procedure. It will make a call from the B1 channel that returns through the B2 channel. The D and B channels will be tested for line integrity.

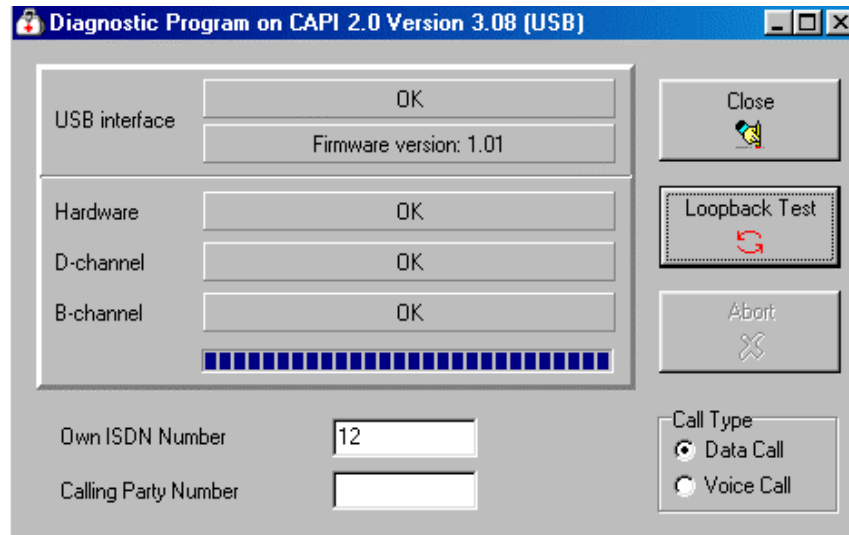

Uninstalling BIPAC-221

If you decide to permanently remove the driver and utility of the USB ISDN TA from your system, you must run the uninstallation program from the ISDN Utility program group as follows:

1. Click “Start”, “Programs” and click the “ISDN Utility” item.
2. Click the “Uninstall DRV & UTL” item. The following ISDN Uninstallation Program window opens.



3. Check the items that you want to completely remove from the Windows system and click “OK”.

Product Support

If you have any problem with the USB ISDN TA, please contact the dealer where you bought this product. If you have any other question, you can contact *Billion Electric Co., Ltd.* directly at the following email address: support@billion.com.tw

You can also download upgraded driver or software utilities for free from Billion's web site at <http://www.billion.com.tw/>



For more detailed instructions on configuring and using the device, please refer to the on-line manual in the installation CD.